

# Specification of Battery Charger

**MODEL: 2460SR-1**

**24V / 30A IP-54 LEAD ACID BATTERY CHARGER**



# Contents

<b>1. General</b>	<b>3</b>
<b>2. Main product specification</b>	<b>3</b>
<b>3. Environmental condition</b>	<b>3</b>
<b>4. Electrical characteristics</b>	<b>4</b>
1).Input characteristics	4
2).Output characteristics	4
3). Protection characteristics	5
4). Charger(LED) indicator	5
<b>5. Safety &amp; EMC</b>	<b>6</b>
<b>6. Environmental testing requirements</b>	<b>7</b>
<b>7. Mechanical characteristics</b>	<b>7</b>
1).Input terminator diagram & definition	8
2).Output terminator diagram & definition	8
3).WEIGHT: (ABOUT 8.5Kg)	8
<b>8. Package, transportation &amp; storage</b>	<b>8</b>
<b>9. Reliability requirements</b>	<b>9</b>
<b>10. Charger wiring</b>	<b>9</b>
<b>11. Interlock Function</b>	<b>9</b>
<b>12. Label    13. Charging Curve</b>	<b>10</b>
<b>14. Mechanical outline</b>	<b>11</b>

## 1. General

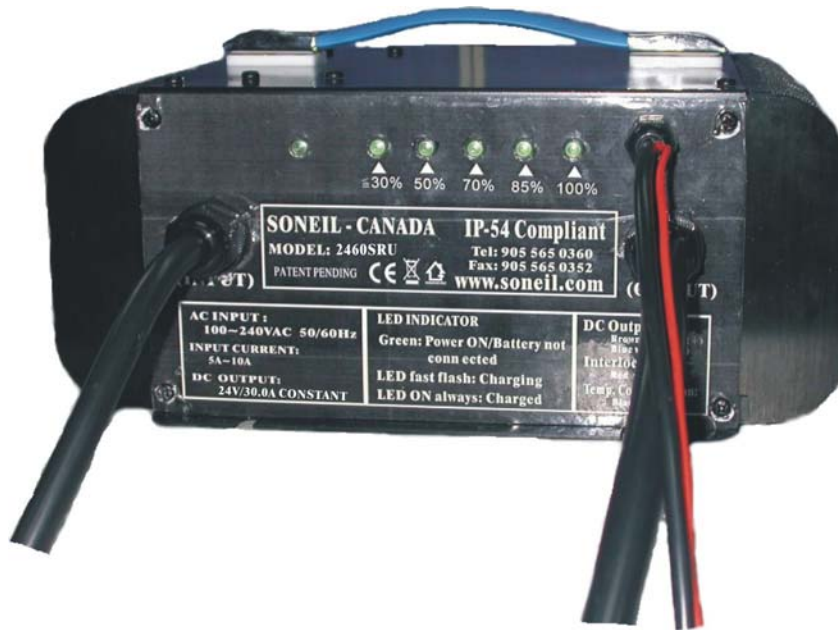

The Soneil 2460SR-1 switch-mode battery charger is a sophisticated fully automatic three-stage battery charger with no fan. It's designation strictly follows EMC requirements, meets requirements of household electrical equipment standards, UL, cUL and CE requirements.

Battery Charger 2460SR-1 is IP54-compliant and can be used to charge any gel, sealed and wet lead-acid batteries.

## 2. Main products specification

Max. output power	Input voltage range	Output voltage	Output current range
840W	90 - 264Vac	+28.8Vdc +/-0.2Vdc	29.5 - 30.5A

## 3. Environmental condition

No.	Item	Technical specification	Unit	Remark
1	Humidity	5%-95%	%	
2	Altitude	≤3000	m	Work normally
3	Cooling	No fan-convectional cooling		Working under full load

#### 4. Electrical characteristics

<b>1 Input characteristics</b>				
<b>No.</b>	<b>Item</b>	<b>Technical specification</b>	<b>Unit</b>	<b>Remark</b>
1.1	Rated input voltage	115/230	Vac	Work normally
1.2	Input voltage range	90 - 264	Vac	
1.3	AC input voltage frequency	47—63	Hz	
1.4	Max input current	4-8	A	Vin=230Vac, Vin=115Vac, rated load
1.5	Fuse	20A/250V		Fitted with 20A/250V slow burn ceramic fuse soldered directly on the PCB
<b>2 Output characteristics</b>				
<b>No.</b>	<b>Item</b>	<b>Technical requirements</b>	<b>Unit</b>	<b>Remark</b>
2.1	Fast charge voltage	28.8 +/- 0.2	Vdc	
2.2	Floating voltage	27.2 +/- 0.2	Vdc	
2.3	Constant current	30	A	
2.4	Power efficiency	84%-90%		At 115Vac&230Vac input voltage
2.5	Power Factor correction	0.99		Active PFC

<b>3 Protection characteristics</b>				
<b>No.</b>	<b>Item</b>	<b>Technical requirements</b>	<b>Unit</b>	<b>Remark</b>
3.1	Software over voltage protection	The charger software limits the maximum output voltage to a level suitable for the connected battery system at 29.5V +/- 0.2V	V	Ambient temp. 27 deg.C
3.2	Temperature compensation	An internal temperature monitor reduces charger output power in extreme operational temperature to prevent damage		Charger shuts down when Max. ambient temp. reaches 55 deg.C
3.3	Output current limiting protection	32A	A	Charger shuts down
3.4	Output short circuit protection	Short circuit protection should automatically recover after removing the fault		
3.5	Electronic reverse battery protection	The charger is electronically protected against permanent reverse battery connection		
3.6	Cell short circuit timer	The battery terminal voltage must exceed 42V within the first 4 minutes of charging or the battery is determined to have a short circuit and charging is terminated		Charger stops charging
<b>4 Charger (LED) indicator</b>				
<b>No.</b>	<b>Item</b>	<b>Status LED</b>	<b>Remark</b>	
1	Deep charge	LED fast flash twice	Removes sulfation	
2	Fast charging	LED fast flash	Constant voltage	
3	Floating charge	LED always ON	Current reduces to 20% - 30% of CC	
4	Maintain charge	LED always ON		

The charging level of the battery is indicated by five LED ladder lights which indicates the charged capacity of the battery in percentages of ≤30%, 50%, 70%, 85% and 100%.

## 5. Safety & EMC

No.	Item		Standard( or testing condition )	Remark
1	Electrical strength test	Primary—secondary	1500Vac/10mA/1min	No breakdown
		Input—ground	1500Vac/10mA/1min	
2	Isolation resistance	Input—ground	$\geq 10M\Omega @ 500Vdc$	
		Output—ground	$\geq 10M\Omega @ 500Vdc$	
3	Leakage current		<3.5mA	At Vin 115Vac &230Vac,50—60Hz
4	SAFETY			Meets UL/cUL/CE requirements
5	EMC	RE	CLASS B	EN55014/EN55014
		CE	CLASS B	EN55014/EN55014
		Air discharge	LEVEL 3	EN61000-4-2
		Contact discharge	LEVEL 3	EN61000-4-2
		RS	LEVEL 3	EN61000-4-3
		CS	LEVEL 3	EN61000-4-6
		EFT	LEVEL 3	EN61000-4-4
		Surge	LEVEL 3	EN61000-4-5,differential module 1 KV, common module 2KV.

## 6. Environmental testing requirements

No.	Item	Technical specification	Remark
1	High temperature ambient operating	+50deg.C	Features ok
2	Low temperature ambient operating	-10deg.C	Features ok
3	High temperature storage	+70deg.C	Work normally after recovery under normal temperature for two hours
4	Low temperature storage	-40deg.C	Work normally after recovery under normal temperature for two hours
5	Random Vibration	20Hz to 2000Hz 3Grms 20hours per axis	
6	Repetitive Shock	40g peak 3 orthogonal axes, 3+ and 3- in each axis ,11ms Pulse width	
7	Thermal shock:	-35deg.C to +75deg.C, <3minute transition, 2.5hour dwell, 200cycle	
8	Drop test:	BS EN60068-2-32: 1993 Test Ed: Free fall, appendix B	

## 7. Mechanical characteristics

**Outline dimension** ( Unit : mm ) length × width × height =270×220×120mm (10.6”x 8.6”x 4.7”)

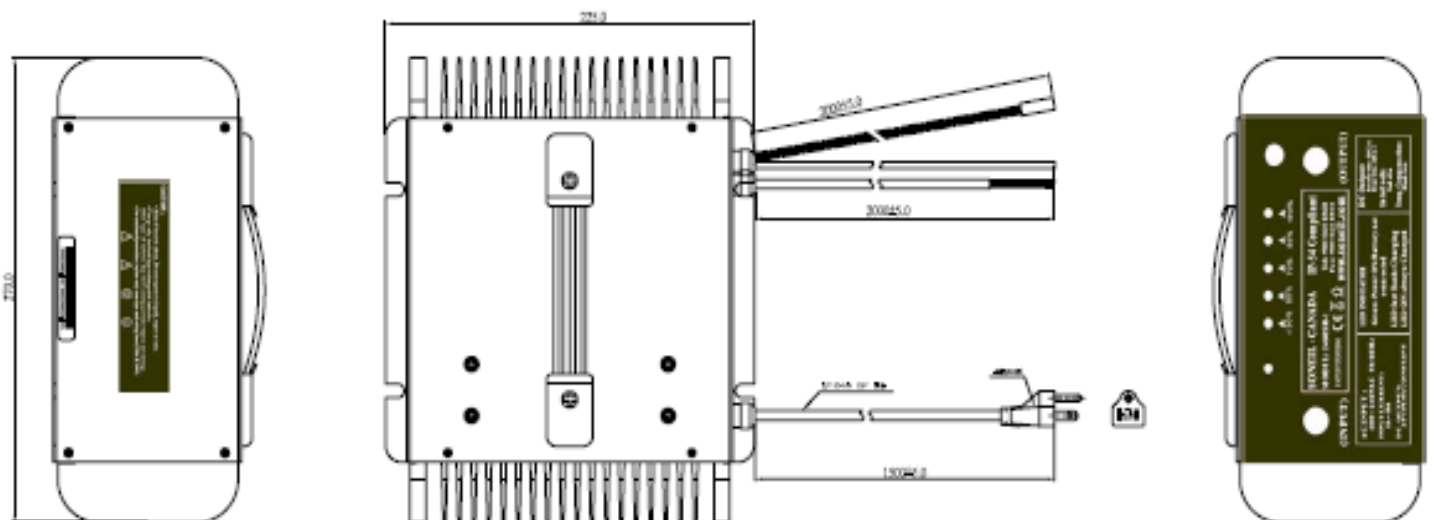

Tolerance of outline dimension is  $\pm 0.5\text{mm}$  , others are  $\pm 0.2\text{mm}$  in the diagram;

### 1) Input terminator diagram & definition

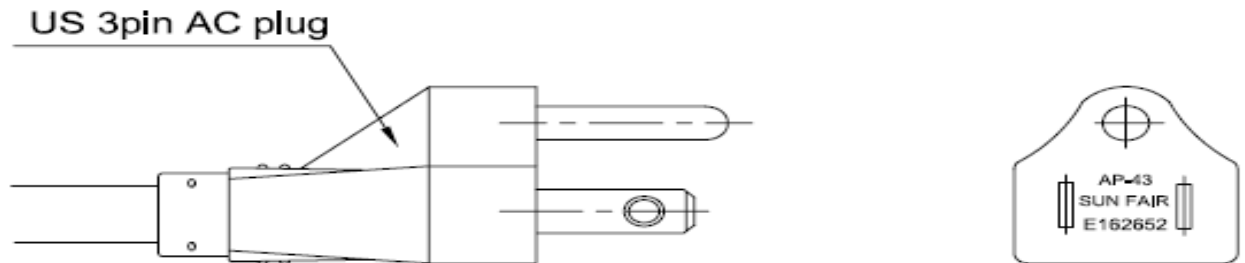

### 2) Output terminator diagram & definition:

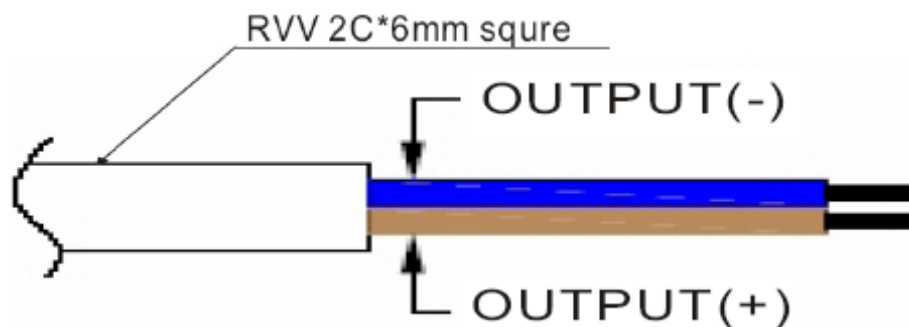

### 3) WEIGHT: ABOUT 8.5Kg (18.7lbs)

## 8. Package, transportation & storage

### 1) Package

There are product name, model, name of manufacturer, safety approval, serial number on the label and User/Operation Manual in the packing box.

### 2) Transportation

Suitable for transportation by truck, ship, and plane. The products should be shielded by tent from sunshine, and loaded and unloaded carefully.

### 3) Storage

Products should be stored in package box when it is not used. And warehouse temperature should be  $-40\text{deg.C} \text{ --- } +70\text{deg.C}$ , and relative humidity is  $5\% \text{ --- } 95\%$ . In the warehouse, there should not be harmful gas, inflammable, explosive products, and corrosive chemical products, and strong mechanical vibration, shock and strong magnetic field affection. The package box should be above ground at least 20cm height, and 50cm away from wall, thermal source, and vent.

## 9. Reliability requirements

### 1) Reliability

MTBF ( standard, environmental temperature, load requirement )  $\geq 30\,000$  hrs ; testing condition :  
25deg.C full load , testing proved value.

## 10. Charger wiring

The basic power wiring for the charger is shown in Item No.7 (7.1 &7.2).

Output +ve: Brown

Output -ve: Blue

Interlock: Red

Temp.compensation: Black

- 1) A spark is often seen on first connection of the charger to the battery terminals due to charging of the internal output capacitors. This is Normal and should not lead to undue concern and care should be taken to ensure the battery vent caps are closed and there are no flammable object in the vicinity of where the connection will be made
- 2) The charger has been calibrated to take account of the voltage drop in the DC output cables during operation. To prevent the possibility of over or under charging of the battery it is recommended the DC output cables are connected directly to the battery without modification. Soneil is able to customize cable lengths and connections for volume customers with specific requirements.

## 11. Interlock function:

1. **Relay has to be AC activated\*(turn on when AC is plugged-in)**
2. **Relay has to be NC (Normally Closed) when AC is ON**
3. **Relay has to be OPEN when AC is OFF**

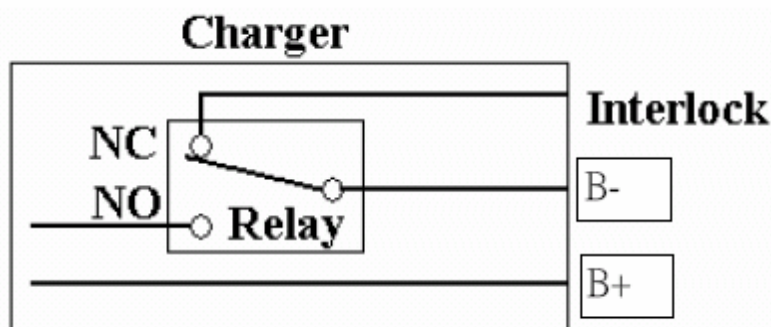

\*The charger has a third output Red wire for interlock function. This will prevent the electrical vehicle motor, head-lights etc. from functioning when the batteries are being charged. The

Interlock wire is internally connected to a relay, which connects to the B-cable inside the charger (see diagram)

## 12. Label

**CAUTION :**

- Risk of electric shock. Do not expose to liquid, vapor or rain.
- Charge only lead-acid type rechargeable batteries.  
Other types of batteries may burst causing personal injury and damage.
- For continued protection replace only same type and rating fuse:(T20A H 250V).





●
●
●
●
●
●
●

▲
▲
▲
▲
▲



≤30%
50%
70%
85%
100%

○  
**(INPUT)**

**SONEIL - CANADA**    **IP-54 Compliant**

**MODEL: 2460SR-1**    Tel: 905 565 0360

PATENT PENDING    Fax: 905 565 0352



[www.soneil.com](http://www.soneil.com)

○  
**(OUTPUT)**

<b>AC INPUT :</b> <b>100~240VAC 50/60Hz</b> <b>INPUT CURRENT:</b> <b>5A-10A</b> <b>DC OUTPUT:</b> <b>24V/30.0A CONSTANT</b>	<b>LED INDICATOR</b> <b>Green: Power ON/Battery not</b> <b>connected</b> <b>LED fast flash: Charging</b> <b>LED ON always: Charged</b>	<b>DC Output:</b> <b>Brown wire- DC(+)</b> <b>Blue wire- DC(-)</b> <b>Interlock:</b> <b>Red wire</b> <b>Temp. Compensation:</b> <b>Black wire</b>
--	--	---

## 13. Charging Curve

Please see separate attachment.

Note: This Specification is subject to change without notice.

For more detail and accurate information on the charger contact Soneil by email or call via phone

## **14. Mechanical outline**



**CHARGING CURVE  
MODEL 2460SR-1**

**SONEIL 24V/30A IP 54 CHARGER**

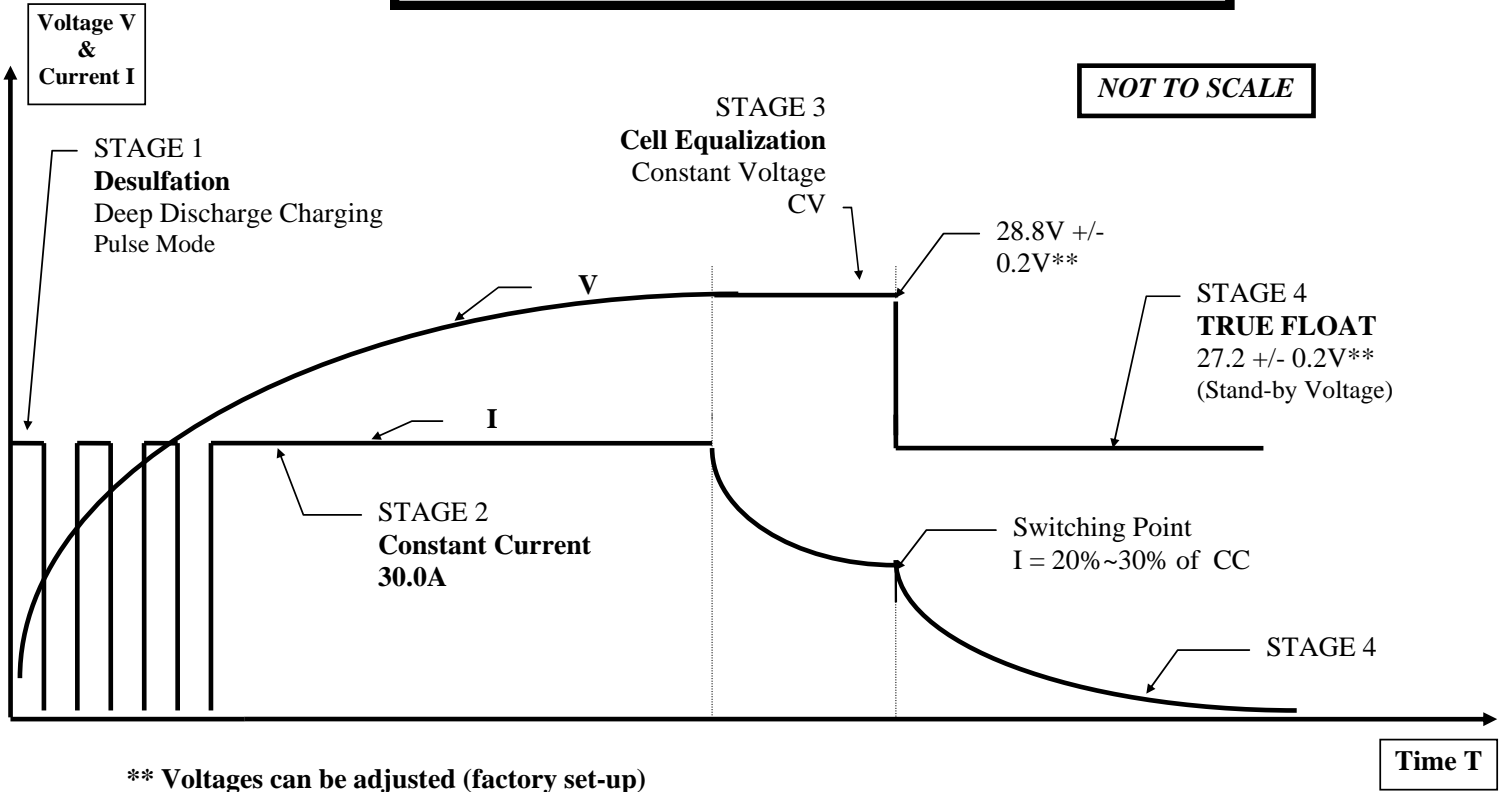

Ref: Curve2460SR-1.22-Apr-08